

C.M. TECHNOLOGY

Designed and Manufactured in Australia

www.cmtechnology.com.au

PRODUCT SHORTFORM

Rev. B1

Tel: +61 (2) 9764 5655

DC-DC Converter

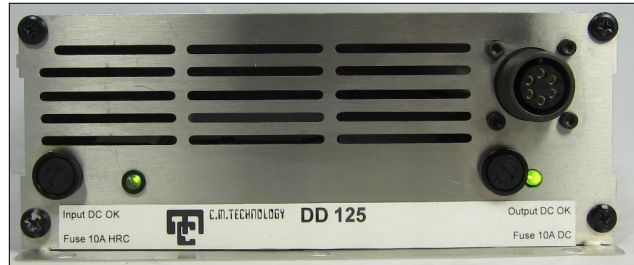

DD12 Series

The DD12 Series is a compact 12VDC Input to DC Converter.

Available in 5V, 12V & 24V DC Output configurations.

- Panel Mount MIL-C rated connector
- Input Panel Mount Fuse
- 100% full load burn in tested
- Built-in Electromagnetic Interference filter
- Low ripple noise
- Overload/Overvoltage/Over temperature protection



Available Configurations

DD125	12 V input, 5V @ 10 A output
DD1212	12 V input, 12V @ 4.2 A output
DD1224	12 V input, 24V @ 2.1 A output

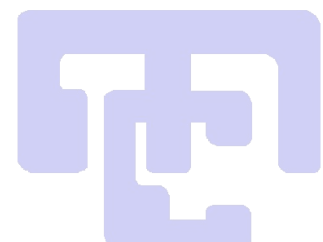

A Caspian Technology Company

© All materials presented are Trademarked and Copyright of C.M. TECHNOLOGY Pty Ltd

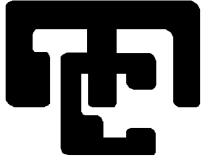

Specifications for DD125 type:

Output DC Voltage	5V
Output Rated Current	10A
Current Range	0-10A
Rated Power	50W
Ripple & Noise (Maximum)	100mVpeak-to-peak
Voltage Tolerance	±2.0%
Line Regulation	±0.5%
Load Regulation	±0.5%
Setup, Rise Time	2.5s
Hold up Time (Typical)	50ms at full load
Input Voltage Range	9.2-18V DC
Efficiency (Typical)	70%
Overload Protection	105-150% rated output power
Overvoltage Protection	5.75 - 6.75V
EMS Immunity	EN61000-4-2,3,4,6,8, ENV50204, EN 55024, Heavy industrial, Criteria A
EMI Conduction & Radiation	EN55022 (CISPR22) Class B
Isolation Resistance	Input-Output, Input-Ground, Output-Ground: 100 MΩ/500V DC/25°C/70% Room Humidity
Withstand Voltage	Input-Output: 1.5KV DC, Input-Ground: 1.5KV DC, Output-Ground: 0.5KV DC
Safety Standards	Compliant with Low Voltage Directive (LVD) 2006/95/EC
MTBF	365.6Khrs min. MIL-HDBK-217F (25°C)
Vibration	10 ~ 500Hz, 2G 10min./1cycle, 60min. each along X, Y, Z axis
Working Temperature	-10°C - +60°C (No derating)
Working Humidity	20% - 90% Room Humidity Non-condensing
Storage Temperature & Humidity	-20°C - +85°C, 10% ~ 95% Room Humidity

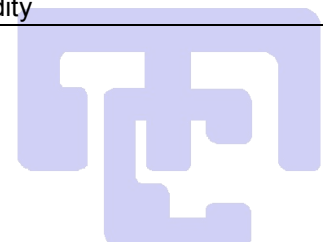

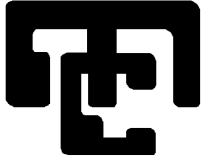

Specifications for DD1212 type:

Output DC Voltage	12V
Output Rated Current	4.2A
Current Range	0-4.2A
Rated Power	50.4W
Ripple & Noise (Maximum)	120mVpeak-to-peak
Voltage Tolerance	±1.0%
Line Regulation	±0.3%
Load Regulation	±0.3%
Setup, Rise Time	2.5s
Hold up Time (Typical)	50ms at full load
Input Voltage Range	9.2-18V DC
Efficiency (Typical)	72%
Overload Protection	105-150% rated output power
Overvoltage Protection	16.8 - 20V
EMS Immunity	EN61000-4-2,3,4,6,8, ENV50204, EN 55024, Heavy industrial, Criteria A
EMI Conduction & Radiation	EN55022 (CISPR22) Class B
Isolation Resistance	Input-Output, Input-Ground, Output-Ground: 100 MΩ/500V DC/25°C/70% Room Humidity
Withstand Voltage	Input-Output: 1.5KV DC, Input-Ground: 1.5KV DC, Output-Ground: 0.5KV DC
Safety Standards	Compliant with Low Voltage Directive (LVD) 2006/95/EC
MTBF	365.6Khrs min. MIL-HDBK-217F (25°C)
Vibration	10 ~ 500Hz, 2G 10min./1cycle, 60min. each along X, Y, Z axis
Working Temperature	-10°C - +60°C (No derating)
Working Humidity	20% - 90% Room Humidity Non-condensing
Storage Temperature & Humidity	-20°C - +85°C, 10% ~ 95% Room Humidity

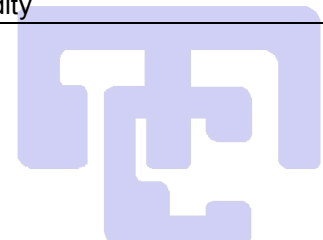

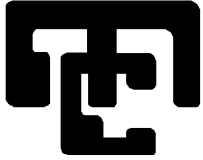

Specifications for DD1224 type:

Output DC Voltage	24V
Output Rated Current	2.1A
Current Range	0-2.1A
Rated Power	50.4W
Ripple & Noise (Maximum)	150mVpeak-to-peak
Voltage Tolerance	±1.0%
Line Regulation	±0.2%
Load Regulation	±0.2%
Setup, Rise Time	2.5s
Hold up Time (Typical)	50ms at full load
Input Voltage Range	9.2-18V DC
Efficiency (Typical)	74%
Overload Protection	105-150% rated output power
Overvoltage Protection	31.5 - 37.5V
EMS Immunity	EN61000-4-2,3,4,6,8, ENV50204, EN 55024, Heavy industrial, Criteria A
EMI Conduction & Radiation	EN55022 (CISPR22) Class B
Isolation Resistance	Input-Output, Input-Ground, Output-Ground: 100 MΩ/500V DC/25°C/70% Room Humidity
Withstand Voltage	Input-Output: 1.5KV DC, Input-Ground: 1.5KV DC, Output-Ground: 0.5KV DC
Safety Standards	Compliant with Low Voltage Directive (LVD) 2006/95/EC
MTBF	365.6Khrs min. MIL-HDBK-217F (25°C)
Vibration	10 ~ 500Hz, 2G 10min./1cycle, 60min. each along X, Y, Z axis
Working Temperature	-10°C - +60°C (No derating)
Working Humidity	20% - 90% Room Humidity Non-condensing
Storage Temperature & Humidity	-20°C - +85°C, 10% ~ 95% Room Humidity

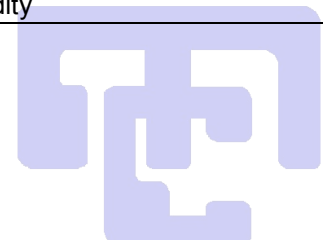

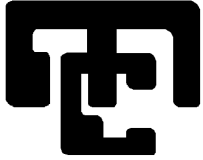
C.M. TECHNOLOGY

Designed and Manufactured in Australia

www.cmtechnology.com.au

PRODUCT SHORTFORM

Rev. B1
Tel: +61 (2) 9764 5655

Overview:

The DD12 Series has been designed to suit the unique requirements of DC-DC converters utilised in industrial applications.

The DD12 Series has been designed for DC supplies ranging from 9.2 to 18 volts.

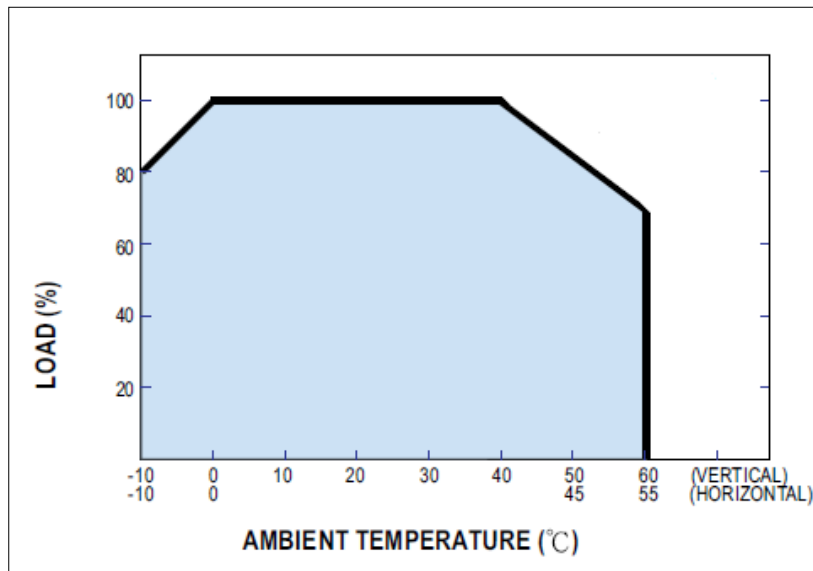

Derating Curve

Manufactured using switchmode electronics, the DD12 series is designed for a high energy efficiency of >70%. This relatively high efficiency allows convection cooling with a maximum 60°C ambient working temperature. Our high quality components are housed in a brushed stainless steel and extruded construction specifically designed for industrial applications.

The finished DC-DC converters are all burnt in at full load to provoke any infant mortality failures, with some products held on long term burn-in.

The DD12 Series is compliant with the Australian C-Tick Standard.

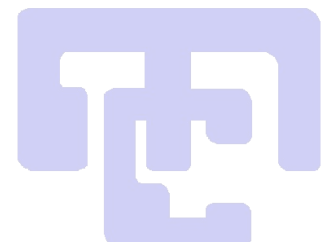

A Caspian Technology Company

© All materials presented are Trademarked and Copyright of C.M. TECHNOLOGY Pty Ltd

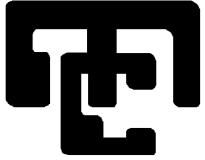

C.M. TECHNOLOGY

Designed and Manufactured in Australia

www.cmtechnology.com.au

PRODUCT SHORTFORM

Rev. B1

Tel: +61 (2) 9764 5655

Dimensions:

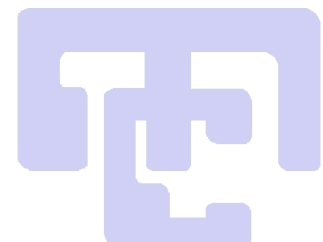
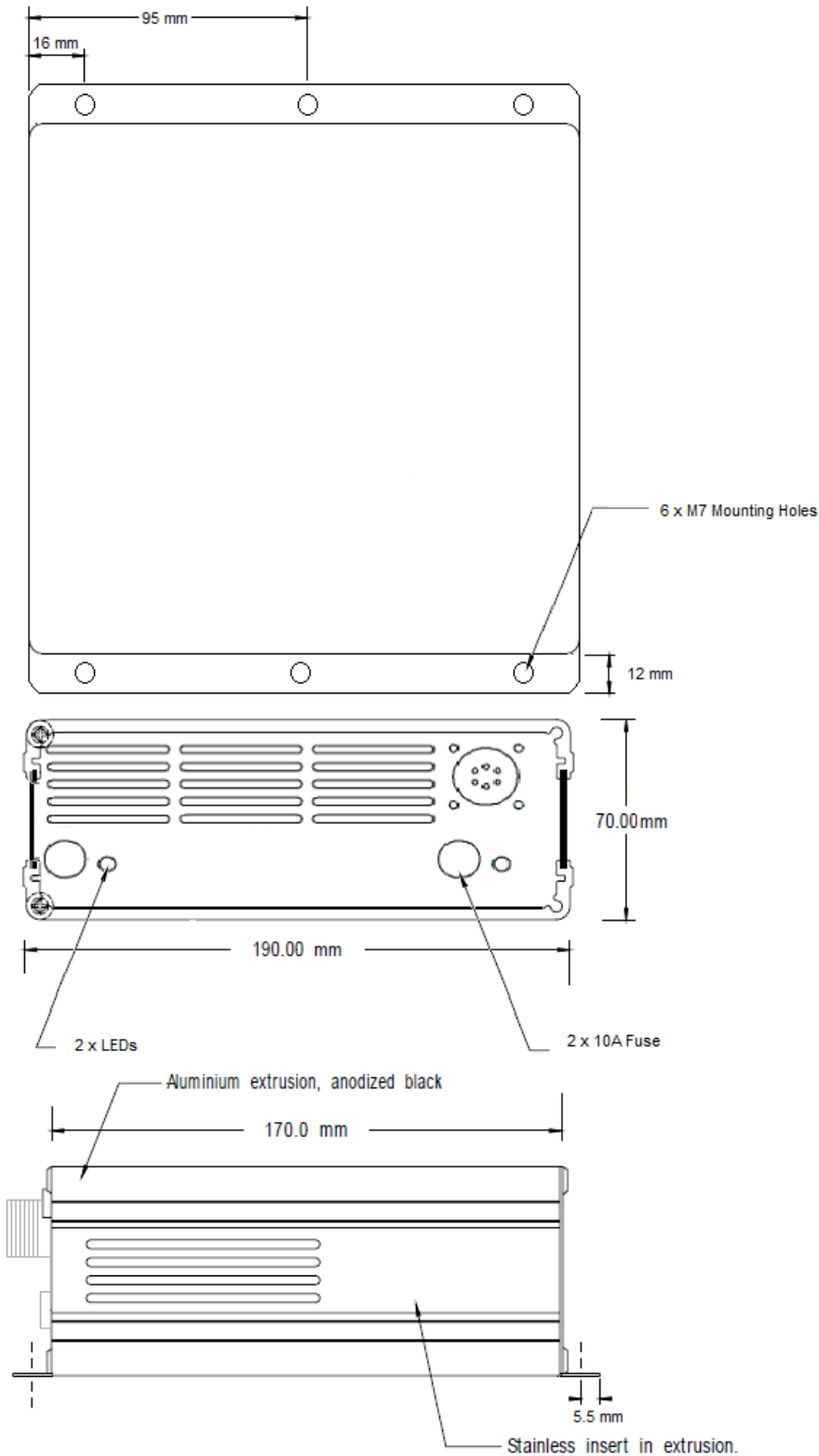

A Caspian Technology Company

© All materials presented are Trademarked and Copyright of C.M. TECHNOLOGY Pty Ltd